

Section 6



DISPLAY ACCESSORIES



Web. acrylicdesign.ie
Email. sales@acrylicdesign.ie

© Acrylic Design 2004-2015

Strip & Hook Merchandisers



SMS 145
Pak strip with header.
White 1mm polyethylene. Header panel 70x89mm
for labels or logo imprints. Holds 10 packages. 75mm space
between hooks. 810mm long.

Minimum order 100 units

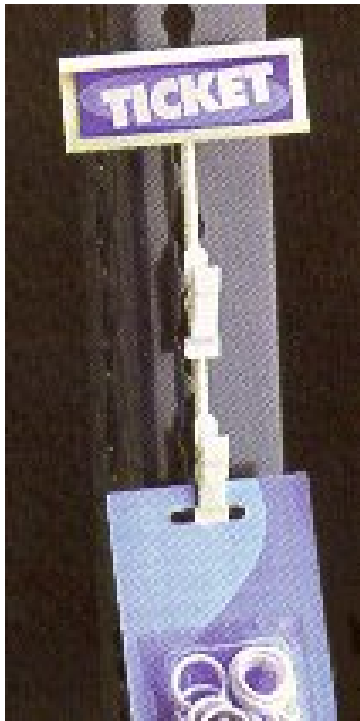

MCS 12H
12 pack metal merchandising strip with header.
Twelve metal spring clips for package attachments.
Header size 32mm high 89mm long.
Beige powder bake finish.

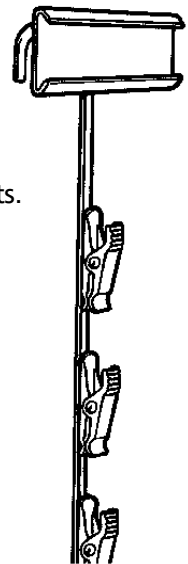

Minimum order 25 units



ACRYLIC DESIGN

& Fabrication Company Limited.

Unit 5a Dunboyne Industrial Estate,

Dunboyne, County Meath.

telephone: 01-802 6480 fax: 01-802 6481

email: sales@acrylicdesign.ie

www.acrylicdesign.ie

Strip & Hook Merchandisers



2120

Multi Gripper with Plugs.

Natural polypropylene. Snap in plugs for secure Hold. Use with Pak Strips in 32mm price channels, On wire fixtures and corrugated cases. 25mm wide.

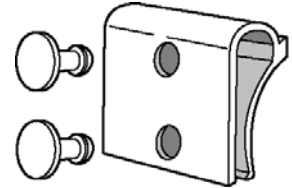

7070

Metal S hook. Galvanized wire. 25mm high.

7080

Metal S hook. Galvanized wire. 38mm high.

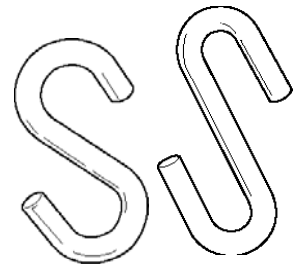

Minimum order 500 units of any one type



ACRYLIC DESIGN

& Fabrication Company Limited.

Unit 5a Dunboyne Industrial Estate,

Dunboyne, County Meath.

telephone: 01-802 6480 fax: 01-802 6481

email: sales@acrylicdesign.ie

www.acrylicdesign.ie

Hanging Poster Systems

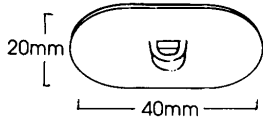

1410
Self adhesive hanging buttons.
Minimum order 500 pieces.

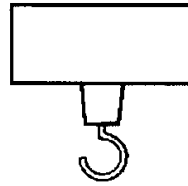

Magnetic hangers.

9551 Maximum weight 6kg.
9555 Maximum weight 9kg.
9556 Maximum weight 12kg.
Minimum order 500 pieces.

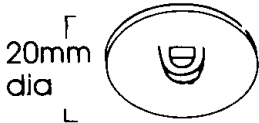

1400
Self adhesive hanging buttons.
Minimum order 500 pieces.

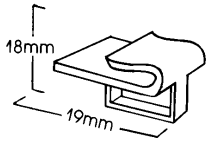

1455
Suspended ceiling hangers
Slide on hangers simply slide onto ceiling strips. Easy to adjust or move.
Minimum order 500 pieces

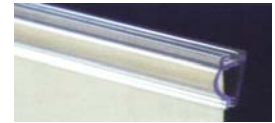

Hanging Banner Rail.

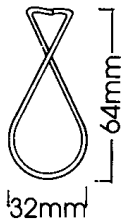

1457
Suspended ceiling hangers
Made in metal, just squeeze to open.
Minimum order 500 pieces.



7006 Hanging clip slides into top channel of extrusion.

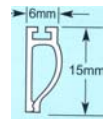

7005 Banner rail accepts paper or thin card. Supplied in 2meter lengths.
Minimum order 500 pieces.

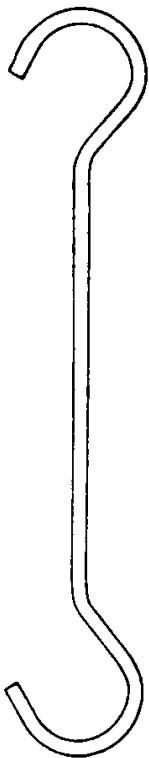

Double hooks comes in twelve standard sizes.

- 1470 100mm.
- 1480 150mm.
- 1490 200mm.
- 1500 250mm.
- 1510 300mm.
- 1520 400mm.
- 1530 510mm.
- 1540 610mm.
- 1550 760mm.
- 1560 910mm.
- 1570 1020mm.
- 1580 1520mm.

Minimum order 500 pieces of any one length.

Extending Wires

Hook it and stretch it !

- 1420 160mm extends to 1 metre.
- 1430 210mm extends to 1.5 metres.
- 1435 330mm extends to 3.5 metres.

A spirally stored wire, not a spring.
Pull it to the disired length..and it stays!

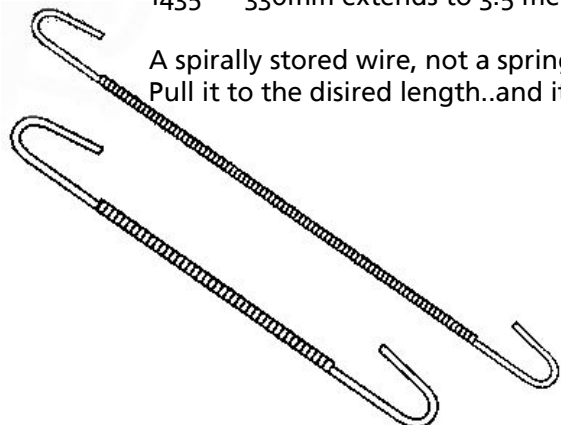

Minimum order 500 pieces of any one length.



ACRYLIC DESIGN

& Fabrication Company Limited.

Unit 5a Dunboyne Industrial Estate,

Dunboyne, County Meath.

telephone: 01-802 6480 fax: 01-802 6481

email: sales@acrylicdesign.ie

www.acrylicdesign.ie

Display Accessories

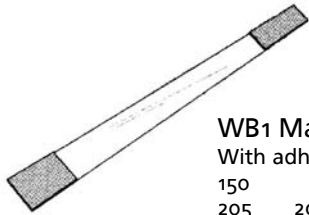

WB1 Manufactured in clear PVC.
With adhesive foam pads at each end.
150 150mm long.
205 205mm long.

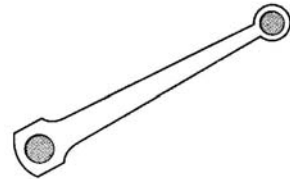

Manufactured in clear PVC.
With adhesive foam pads at each end.
WB2 205mm long.
WB5 205mm long. Pads on opposite sides

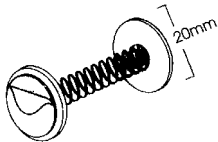

1220
Wobbler Spring
With adhesive pads at each end, make your message move, available in white only

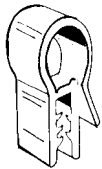

301-050 12mm wide
Wire basket sign holder.
Fits wire up to 10mm thick
accepts material 1mm thick

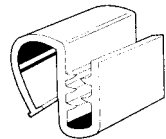

120-100 25mm wide
Wire basket sign holder.
Fits wire up to 10mm thick
accepts material 1.25mm thick

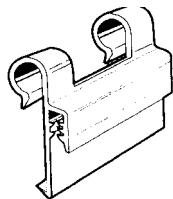

302-1375 25mm & 64mm wide
Wire basket sign holder.
Fits wire up to 10mm thick
accepts material 1mm thick

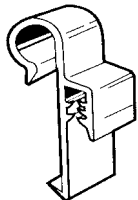

302-375 10mm wide
Wire basket sign holder.
Fits wire up to 10mm thick
accepts material 1mm thick

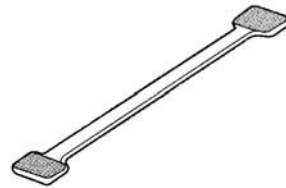

WB3 Manufactured in aluminium.
With adhesive foam pads at each end.
75mm long.

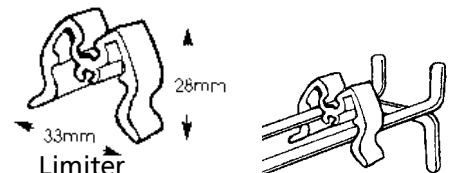

Limiter

This unit limits the amount of stock that you can put on to hooks.

1320

Arrow Bottle Rings

Available in White or Black
Minimum order 10,000 pieces.

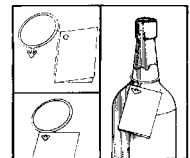
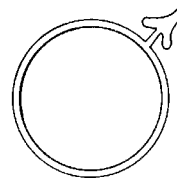

MINIMUM ORDER FOR ANY OF THE ABOVE ITEMS IS 5,000 PIECES



ACRYLIC DESIGN

& Fabrication Company Limited.

Unit 5a Dunboyne Industrial Estate,

Dunboyne, County Meath.

telephone: 01-802 6480 fax: 01-802 6481

email: sales@acrylicdesign.ie

www.acrylicdesign.ie

Suction Cups



SCCo1
Suction Cup Sign Holder.
45mm diameter, clear vinyl.
Suction cup with mushroom head allows
you to hang signs with holes or grommets.
For temporary use on any smooth, flat surface.

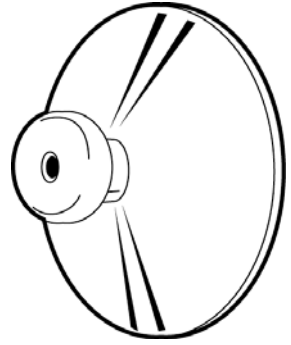

SCCo2
Suction Cup Sign Holder with Metal Hook.
45mm diameter, clear vinyl.
Suction cup with metal hook for one step hanging.
For temporary use on any smooth, flat surface.

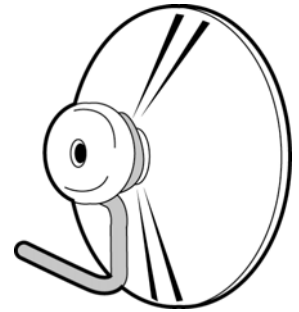

SCCo3
Suction Cup Sign Holder with Plastic Thumbtack.
45mm diameter, clear vinyl.
Suction cup with plastic thumbtack to keep signs in place.
For temporary use on any smooth, flat surface.

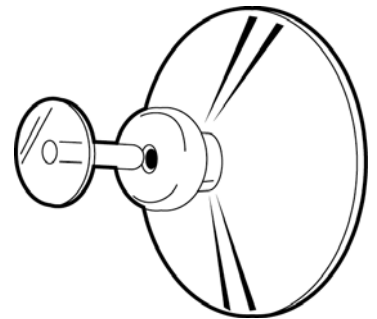

MINIMUM ORDER OF ANY ONE TYPE OF THE ABOVE ITEMS IS 500 PIECES



ACRYLIC DESIGN

& Fabrication Company Limited.

Unit 5a Dunboyne Industrial Estate,

Dunboyne, County Meath.

telephone: 01-802 6480 fax: 01-802 6481

email: sales@acrylicdesign.ie

www.acrylicdesign.ie

Hanging Tabs

Self adhesive merchandising aids designed to hang, reinforce or repair packaging.

Euro Style Tabs

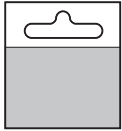

S T21
Clear plastic, clear adhesive backing
50mm wide 50mm high, thickness
0.4mm



MINIMUM ORDER IS 1000 PIECES

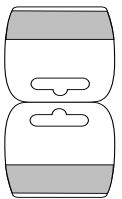

R LHS
For heavier items
Clear plastic, clear adhesive backing
43mm wide 99mm high, thickness
0.4mm

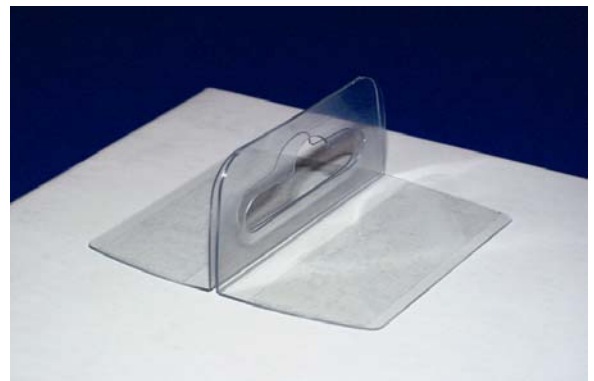

MINIMUM ORDER IS 1000 PIECES



ACRYLIC DESIGN

& Fabrication Company Limited.

Unit 5a Dunboyne Industrial Estate,

Dunboyne, County Meath.

telephone: 01-802 6480 fax: 01-802 6481

email: sales@acrylicdesign.ie

www.acrylicdesign.ie

Display Lock Straps



8350 Secur-A-Tie.
127mm long
Permanent Locking.
Natural Nylon.



8320 Secur-A-Tie.
200mm long
Permanent Locking.
Natural Nylon.



8432 Lock Strap.
100mm long
Permanent Locking.
Natural Nylon.



8376 Lock Strap.
100mm long
Permanent Locking.
Natural Nylon.



8470 Lock Strap.
178mm long
Permanent Locking.
Natural Nylon.



8377 Lock Strap.
200mm long
Permanent Locking.
Natural Nylon.



8471 Lock Strap.
280mm long
Permanent Locking.
Natural Nylon.

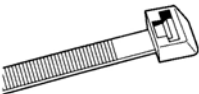

8472 Lock Strap.
381mm long
Permanent Locking.
Natural Nylon.
Extra heavy duty.

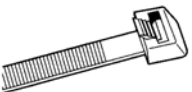

1361 Lock Strap.
190mm long
Releasable.
Release and re-use.

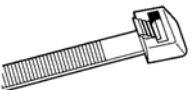

1367 Lock Strap.
280mm long
Releasable.
Release and re-use.

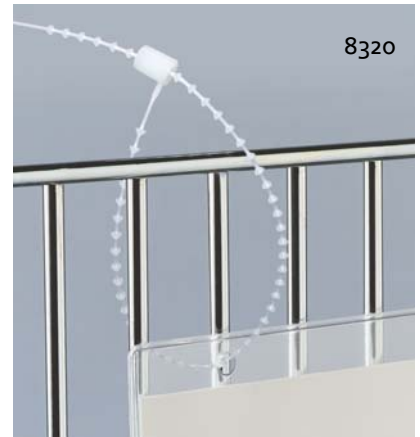

8320



8470

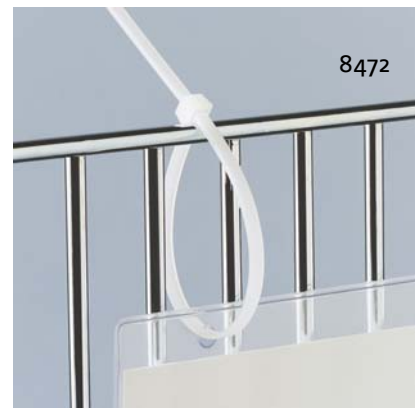

8472



1361

MINIMUM ORDER OF ANY ONE TYPE OF THE ABOVE ITEMS IS 5,000 PIECES



ACRYLIC DESIGN

& Fabrication Company Limited.

Unit 5a Dunboyne Industrial Estate,

Dunboyne, County Meath.

telephone: 01-802 6480 fax: 01-802 6481

email: sales@acrylicdesign.ie

www.acrylicdesign.ie

Adhesive, Velcro, Magnet Tapes & Dots



Magnetic squares 25mm adhesive backed
Minimum order 1000 pieces.



Foam Pads
Piece size (mm) 12.5 x 25 with 5000 per roll.
Piece size (mm) 25 x 25 with 2500 per roll.



Velcro Dots
Black / white 13mm Hook 1500 dots per roll.
Black / white 13mm Loop 1500 dots per roll.
Black / white 22mm Hook 1500 dots per roll.
Black / white 22mm Loop 1500 dots per roll.

Velcro Strips
Black / white 10mm loop adhesive 25 meters per roll.
Black / white 10mm hook adhesive 25 meters per roll.
Black / white 16mm loop adhesive 25 meters per roll.
Black / white 16mm hook adhesive 25 meters per roll.
Black / white 20mm loop adhesive 25 meters per roll.
Black / white 20mm hook adhesive 25 meters per roll.
Black / white 25mm loop adhesive 25 meters per roll.
Black / white 25mm hook adhesive 25 meters per roll.
Black / white 30mm loop adhesive 25 meters per roll.
Black / white 30mm hook adhesive 25 meters per roll.
Black / white 38mm loop adhesive 25 meters per roll.
Black / white 38mm hook adhesive 25 meters per roll.
Black / white 50mm loop adhesive 25 meters per roll.
Black / white 50mm hook adhesive 25 meters per roll.
Black / white 100mm loop adhesive 25 meters per roll.
Black / white 100mm hook adhesive 25 meters per roll.

ALL ABOVE SOLD BY THE ROLL ONLY



ACRYLIC DESIGN

& Fabrication Company Limited.

Unit 5a Dunboyne Industrial Estate,

Dunboyne, County Meath.

telephone: 01-802 6480 fax: 01-802 6481

email: sales@acrylicdesign.ie

www.acrylicdesign.ie